

Thank you for purchasing a **Redleaf Fixed Frame Screen**, please read the following instructions to ensure proper usage of your new equipment.

INSTALLATION INSTRUCTION

1. Slide the 2 pcs M6nuts into the long side slot, and move them to the end of frame separately. fig.1
2. Insert the plastic L parts to the frame to connect them, use M5×10 screws to fix them. fig.2

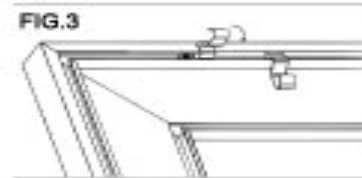
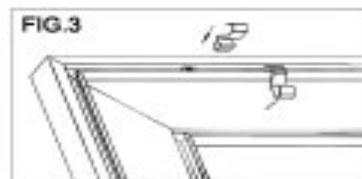
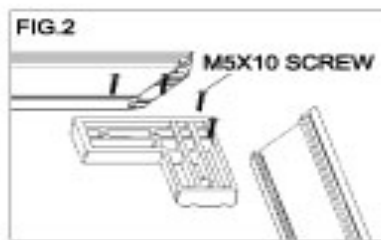
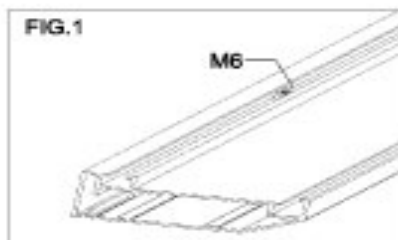

3. Insert the spring hooks into the frame slot, and turn 90°. fig.3
4. Insert the $\Phi 5$ steel rods into the four edges of the screen fabric. Short edges first. fig.4

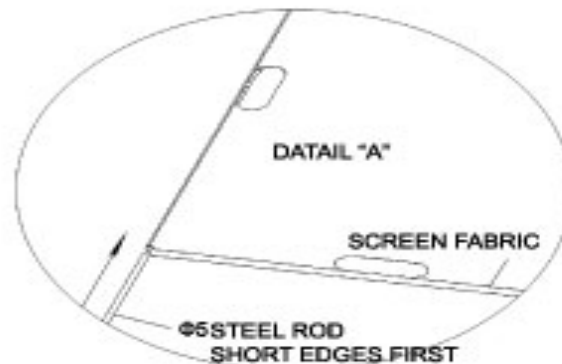

5. Put the prepared screen fabric to the frame. Use the spring hook to fix them. Short edges first. Check and adjust to ensure flatness.
6. Use M6×15 screws to fix the nut, and fix the wall spacer. fig.5
7. Then use the right position to fix the frame screen to the wall. fig.6

Note:put the hooks at the middle of the fabric hole.

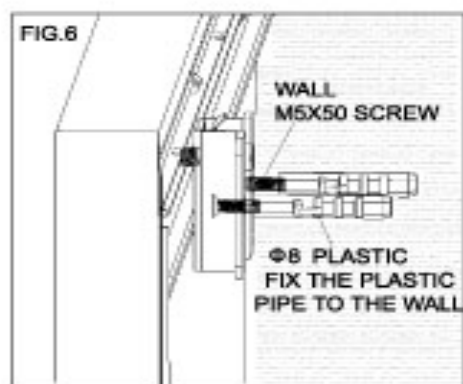
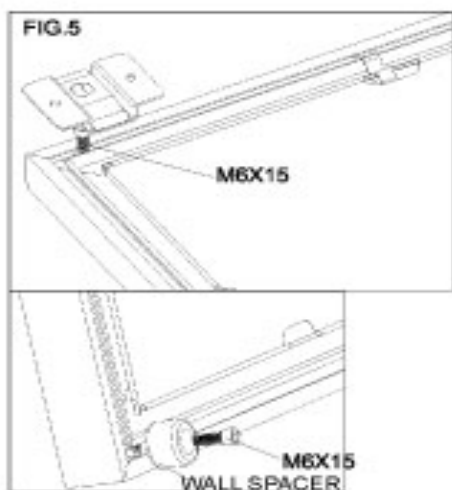

If you have any questions regards this equipment please call the Redleaf Sales office on +61 2 4869 5811 during business hours.